

HARVIA VIRTA

HL700400

The Harvia Virta heater's strong structure and exceptional ease of maintenance make it excellently suitable for those who use the sauna often and like to enjoy the steam for long periods of time.

Advantages

- A reliable heater with sturdy structure for home sauna and professional use
- The large number of stones guarantees soft and abundant steam. Efficient air circulation heats the sauna very quickly
- Sleek and modern design
- The heating elements are separated from the stones, which results in a long heating element life span
- The maintenance hatch on the front enables quick and easy maintenance without touching the stones



Features

Main material : Steel

H x W x D : 810.0 x 415.0 x 410.0 mm

Net weight (kg) : 23.8

Installation location : Floor

ID	GTIN	Output (kW)	Sauna room size min - max m3
HL700400	6410082613113	7 kW	5.0-10.0

Related products



HL1



HL2

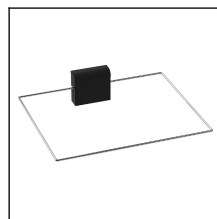

SFE-350400



HL3S

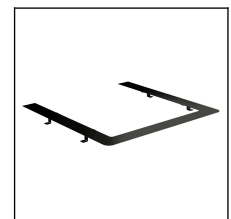

HL1M

Spare parts

Product	ID	Pcs
Adjustable leg	ZSA-440	

Technical details

Technical data	Type / attribute	HL700400
	Color	Black
	Power output	7 kW
	Stone sizes	Ø5–10 cm
	Stone amount (kg)	50
Dimensions	Product width	415
	Product height	810
	Product depth (mm)	410
	Net weight (kg)	23.8
	Gross weight	26
	Package width	505
	Package height	870
	Package depth	440
Safety and installation dimensions	Safety distance front (non-combustible materials)	30
	Safety distance front (combustible materials)	30
	Safety distance side (non-combustible materials)	30
	safety distance to the side wall (combustible materials)	30
	Safety distance behind (non-combustible materials)	30
	Safety distance (Ceiling)	1100
	Room min. height(depends on connections and therefore from output, star/delta)	1900
	Installation opening height	1900
	Installation opening width	475
Installation opening depth	400	

Technical images

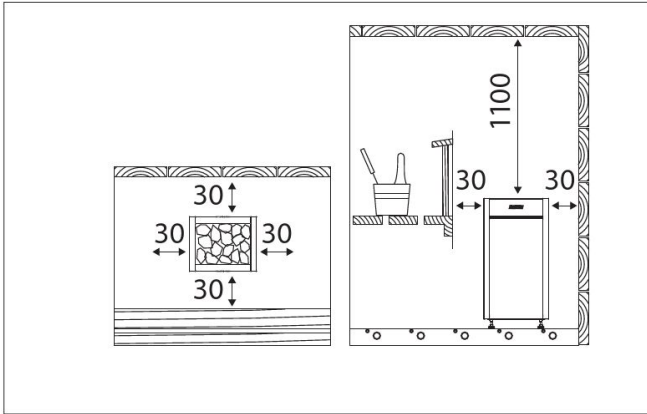

Minimum safety distances (all dimensions in millimeters)

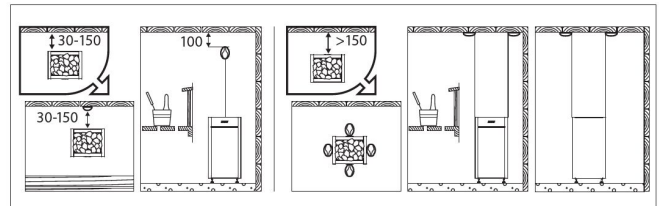

Installing the sensor (all dimensions in millimeters)

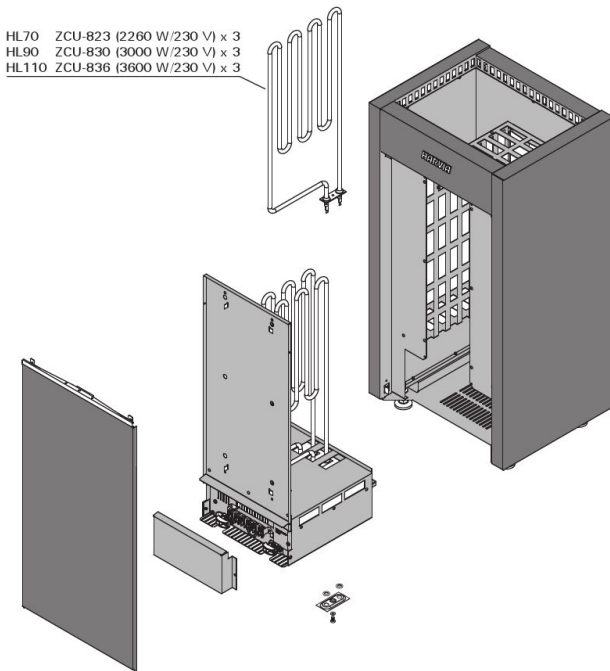

We recommend to use only the manufacturer's spare parts.

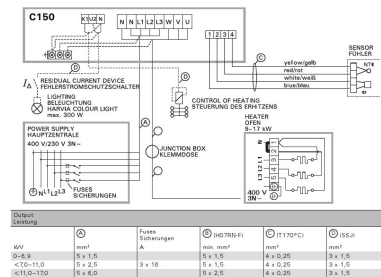

Electrical connections of control unit C150 and HL heater

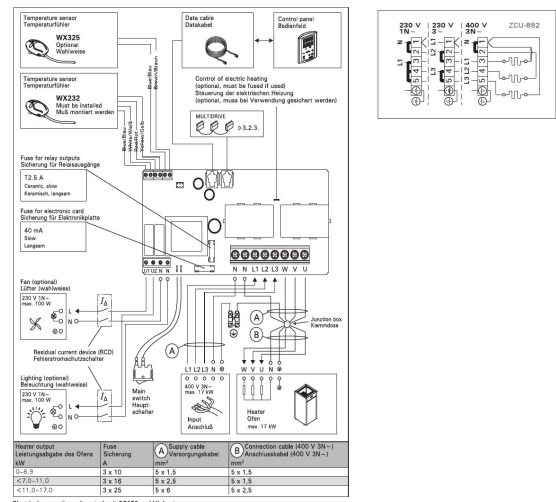

Electrical connections of control unit C275 and HL heater