

HARVIA VEGA

HCBE450400S

The stainless steel outer shell of Vega is durable and creates a modern look for your sauna. The operating switches are placed ergonomically in the upper part, and thanks to the symmetric shape of the heater, the switches can be placed on either side.



Features

Main material : Steel

H x W x D : 540.0 x 480.0 x 310.0 mm

Net weight (kg) : 10.2

Installation location : Wall

| ID | GTIN | Output (kW) | Sauna room size min - max m3 |
|-------------|---------------|-------------|------------------------------|
| HCBE450400S | 6410082608140 | 4.5 kW | 3.0-6.0 |

Related products

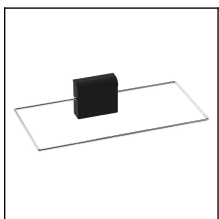

SFE-220400

Spare parts

| Product | ID | Pcs |
|---------------------------------------|-----------|-----|
| Heating element 1500W/230V | ZSB-224 | 3 |
| Thermostat knob Vega 2009 | ZSB-115 | 1 |
| Timer knob Vega 2009 | ZSB-125 | 1 |
| Wall mounting plate Vega | ZSB-200 | 1 |
| Timer 4h+8h | ZSK-510 | 1 |
| Thermostat/overheating limiter switch | ZSK-520 | 1 |
| Heating element 1500W 230V, Vega | SPZSB-224 | 3 |
| Knob thermostat Vega, black | SPZSB-115 | 1 |
| Knob timer 4+8h Vega, black | SPZSB-125 | 1 |
| Timer 4+8h | SPZSK-510 | 1 |
| Thermostat overheating limiter switch | SPZSK-520 | 1 |

Technical details

| Technical data | Type / attribute | HCBE450400S |
|------------------------------------|--------------------------------------------------------------------------------|-----------------|
| | Color | Stainless Steel |
| | Power output | 4.5 kW |
| | Stone amount (kg) | 20 |
| Dimensions | Product width | 480 |
| | Product height | 540 |
| | Product depth (mm) | 310 |
| | Net weight (kg) | 10.2 |
| | Gross weight | 11.6 |
| | Package width | 315 |
| | Package height | 475 |
| | Package depth | 500 |
| Safety and installation dimensions | Safety distance front (non-combustible materials) | 35 |
| | Safety distance front (combustible materials) | 20 |
| | Safety distance side (non-combustible materials) | 35 |
| | safety distance to the side wall (combustible materials) | 20 |
| | Safety distance (Ceiling) | 1100 |
| | Room min. height(depends on connections and therefore from output, star/delta) | 1900 |
| | Installation opening height | 1740 |
| | Installation opening width | 505 |
| | Installation opening depth | 330 |

Technical images

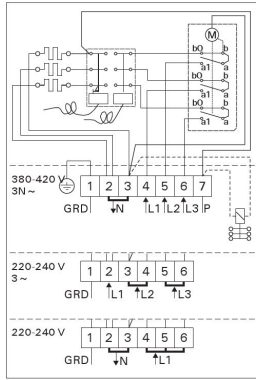

Electrical connections of BC heater
Elektroanschlüsse des Saunaofens BC

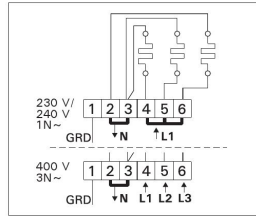

Electrical connections of BC-E heater
Elektroanschlüsse des Saunaofens BC-E

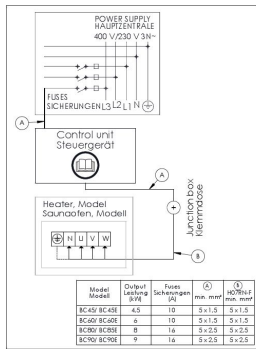

3-phase electrical connections of control unit C150 and BC-E heater
3-phaseser Elektroanschlüsse des Steuergerät C150 und des Saunaofens BC-E

| Model Modell | Control Leuchte S/N | Phase Schwingspannung V | min. mm | Ø max. mm |
|-----------------|---------------------------|-------------------------------|---------|--------------|
| BC45/BC45E | 4,5 | 10 | 5 x 1,5 | 5 x 1,5 |
| BC60/BC60E | 6 | 10 | 5 x 1,5 | 5 x 1,5 |
| BC80/BC80E | 8 | 10 | 5 x 2,5 | 5 x 2,5 |
| BC90/BC90E | 9 | 10 | 5 x 2,5 | 5 x 2,5 |

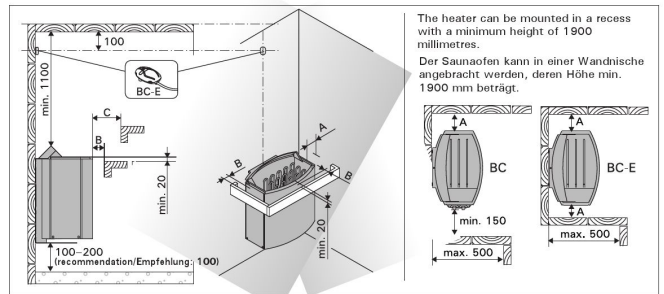

The heater can be mounted in a recess with a minimum height of 1900 millimetres.
Der Saunaofen kann in einer Wandnische angebracht werden, deren Höhe min. 1900 mm beträgt.

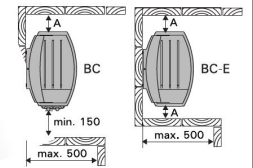

| | A min. from side to wall, upper platform or rail von der Seitenfläche zur Wand, zur oberen Bank oder zum oberen Geländer | B min. | C min. from front surface to upper platform or rail von der Vorderfläche zur oberen Bank oder zum oberen Geländer |
|------------|--------------------------------------------------------------------------------------------------------------------------------|--------|-------------------------------------------------------------------------------------------------------------------------|
| BC45/BC45E | 35 | 20 | 35 |
| BC60/BC60E | 50 | 30 | 50 |
| BC80/BC80E | 100 | 30 | 80 |
| BC90/BC90E | 120 | 40 | 100 |

| SSTL/EGFF | | |
|-----------|---------|----------------------|
| 1 | ZSB-224 | 8266392 1500 W/230 V |
| 2 | ZSB-226 | 8266393 2000 W/230 V |
| 3 | ZSB-228 | 8266394 2670 W/230 V |
| 4 | ZSB-229 | 8266395 3000 W/230 V |
| 5 | ZSK-510 | 8260996 |
| 6 | ZSB-125 | °C (BC) |
| 7 | ZSK-520 | 8260997 |
| 8 | ZSB-115 | °C (BC) |
| 9 | ZSB-200 | |

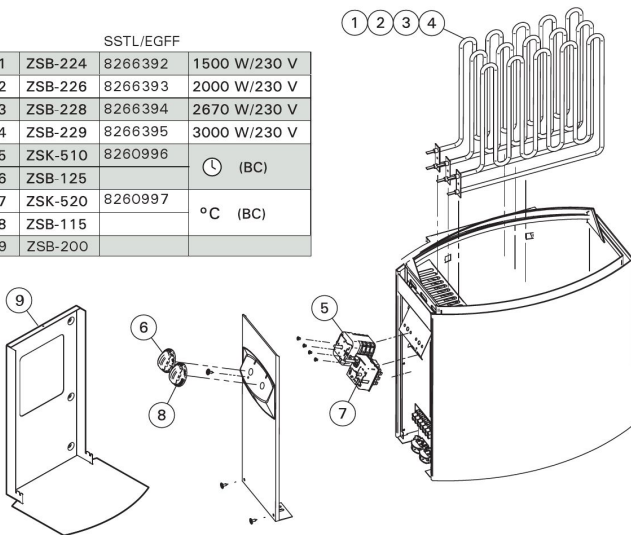

We recommend to use only the manufacturer's spare parts.
Es dürfen ausschließlich die Ersatzteile des Herstellers verwendet werden.